

PHS-208 Parts Breakdown

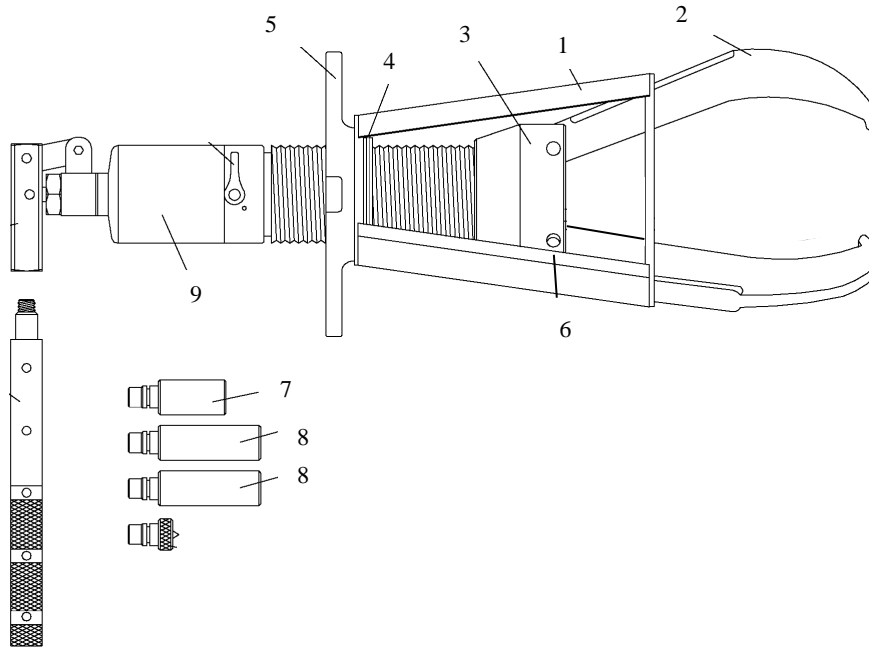

PHS-208

	Description	Part #	LBS	KG
1	Cage (2 Jaw)	PH-20853	2.50	1.14
2	Jaw	10854	2.00	.91
3	Jaw Head Base	PH-20855H	4.90	2.22
4	Snap Ring	PH-10859	.06	.03
5	T-Handle	PH-10857	2.50	1.14
6	Pin	PH-10856	.10	.05
7	Extension Rod 1.90 (48MM)	E1414	.55	.24
8	Extension Rod 2.90 (78MM)	E1165	.40	.18
9	Hydraulic Assembly	PLP1200	14.4	6.53

PLP 1200 Includes:

Description	Part #
Hydraulic Assembly	
Handle Clevis	
Telescopic Handle	
Cone Assembly	
Extension Rod 1.90 (48mm)	E1414
Extension Rod 2.90 (74mm)	E1165