



100-TON & 200-TON Hydraulic Puller Systems

INSTRUCTION & PARTS SHEET

IMPORTANT: READ CAREFULLY!

IMPORTANT RECEIVING INSTRUCTIONS:

Visually inspect all components for shipping damage. Shipping damage is not covered by warranty. If shipping damage is found notify the carrier at once. The carrier is responsible for all repair and replacement costs resulting from damage in shipment.

SAFETY FIRST:

It is impossible to predict the exact force needed for every pulling situation. The amount of press-fit and force of removal can vary greatly between jobs. The set-up requirements along with the size, shape and condition of the parts being pulled are all variables which must be considered. Remember that a significant amount of force can be exerted with a puller. Respect this force and always observe safety precautions. Failure to comply with the following cautions and warnings could cause equipment damage or personal injury.



WARNING: DO NOT touch or handle hydraulic hoses or fittings with pressure in the system. Escaping oil under pressure may cause serious injury. If oil is injected under the skin see a doctor immediately.

DO NOT make any electrical adjustments with electrical power active in the system.

DO NOT make or break any hydraulic connections with pressure in the system.

DO NOT overload the equipment. Use the right size puller.

DO NOT stand on, under or near the puller while in use. Keep hands, feet and clothing away from moving parts.

To avoid personal injury and equipment damage, make sure all hydraulic components withstand the maximum hydraulic pressure of 700 bar (10,000 psi).

Make sure all system components are protected from external sources of damage, such as excessive heat, flame, moving machine parts, sharp edges and corrosive chemicals.

Always check to ensure that all cylinders and components are securely fastened.



IMPORTANT: Inspect puller for dents, cracks, or excessive wear before each use. Immediately replace worn or damaged parts.

It is recommended to use 3-jaw puller whenever possible for a more secure grip, a more even pulling force and better stability.

Cover application with a protective blanket before applying force. Since high force is applied on the part being pulled, breakage may occur and user may be exposed to flying debris.

Use hydraulic gauges in each hydraulic system to indicate safe operating loads.

Apply force gradually. Be sure the puller is square with the component to be pulled.

Wear safety glasses or other approved eye protection.

Keep hands away from possible pinching points.

Always make sure the puller is aligned with the shaft.

Select the appropriate ram extender for each application.

Always place the puller in the lowest position and remove ram extenders while transporting.

Keep slide rollers and mast clean and lubricated.

Always keep puller hoist vertical and the control valve closed when not adjusting vertical position.

A small amount of oil seepage is normal from breather vent on hoist cylinder.

Use only genuine POSI LOCK parts and endorsed hydraulic components.



CAUTION: Make sure that all items being pulled are supported by a means other than the puller. When using a puller in excess of 50 pounds, support puller by other means than a single person. Do not use the puller for lifting or supporting objects.

Avoid sharp bends and kinks in hoses as they may lead to premature hose failure. Inspect hoses and fittings for leaks or damaged areas. Immediately discard and replace damaged components.

POSI LOCK® 100-TON & 200-TON Hydraulic Puller Systems

Instructions applicable to part numbers described below:

Portable 100-Ton Hydraulic Puller Systems

Model Number	Capacity Tons (kN)	Number of Jaws	Dimensions							Weight lbs. (kg)
			Spread A in. (mm)	Overall Length B in. (mm)	Reach C in. (mm)	Jaw Length D in. (mm)	Jaw Tip Width E in. (mm)	Tip Clearance F in. (mm)	Tip Depth G in. (mm)	
Single Acting										
PH-102T	100 tons (890 kN)	2	7.5 to 70 in. (191 to 1778 mm)	77 in. (1956 mm)	50 in. (1270 mm)	53 in. (1346 mm)	1.25 in. (32 mm)	3.5 in. (89 mm)	3.5 in. (89 mm)	1700 lbs. (771 kg)
PH-100T	100 tons (890 kN)	3	7.5 to 70 in. (191 to 1778 mm)	77 in. (1956 mm)	50 in. (1270 mm)	53 in. (1346 mm)	1.25 in. (32 mm)	3.5 in. (89 mm)	3.5 in. (89 mm)	1950 lbs. (885 kg)
PH-123T	100 tons (890 kN)	2/3	7.5 to 70 in. (191 to 1778 mm)	77 in. (1956 mm)	50 in. (1270 mm)	53 in. (1346 mm)	1.25 in. (32 mm)	3.5 in. (89 mm)	3.5 in. (89 mm)	2000 lbs. (907 kg)
Single Acting Vertical										
PH-102TV	100 tons (890 kN)	2	7.5 to 70 in. (191 to 1778 mm)	77 in. (1956 mm)	50 in. (1270 mm)	53 in. (1346 mm)	1.25 in. (32 mm)	3.5 in. (89 mm)	3.5 in. (89 mm)	1800 lbs. (816 kg)
Double Acting										
PH-102TDA	100 tons (890 kN)	2	7.5 to 70 in. (191 to 1778 mm)	77 in. (1956 mm)	50 in. (1270 mm)	53 in. (1346 mm)	1.25 in. (32 mm)	3.5 in. (89 mm)	3.5 in. (89 mm)	1800 lbs. (816 kg)
PH-100TDA	100 tons (890 kN)	3	7.5 to 70 in. (191 to 1778 mm)	77 in. (1956 mm)	50 in. (1270 mm)	53 in. (1346 mm)	1.25 in. (32 mm)	3.5 in. (89 mm)	3.5 in. (89 mm)	2050 lbs. (930 kg)
PH-123TDA	100 tons (890 kN)	2/3	7.5 to 70 in. (191 to 1778 mm)	77 in. (1956 mm)	50 in. (1270 mm)	53 in. (1346 mm)	1.25 in. (32 mm)	3.5 in. (89 mm)	3.5 in. (89 mm)	2100 lbs. (953 kg)
Double Acting Vertical										
PH-102DATV	100 tons (890 kN)	2	7.5 to 70 in. (191 to 1778 mm)	77 in. (1956 mm)	50 in. (1270 mm)	53 in. (1346 mm)	1.25 in. (32 mm)	3.5 in. (89 mm)	3.5 in. (89 mm)	1800 lbs. (816 kg)

200-Ton Hydraulic Puller System

Model Number	Capacity Tons (kN)	Number of Jaws	Dimensions							Weight lbs. (kg)
			Spread A in. (mm)	Overall Length B in. (mm)	Reach C in. (mm)	Jaw Length D in. (mm)	Jaw Tip Width E in. (mm)	Tip Clearance F in. (mm)	Tip Depth G in. (mm)	
PH-200T	200 tons (1779 kN)	4	8 to 70 in. (203 to 1778 mm)	78.5 in. (1994 mm)	48 in. (1219 mm)	53 in. (1346 mm)	1.25 in. (32 mm)	3.5 in. (89 mm)	3.5 in. (89 mm)	4150 lbs. (1882 kg)

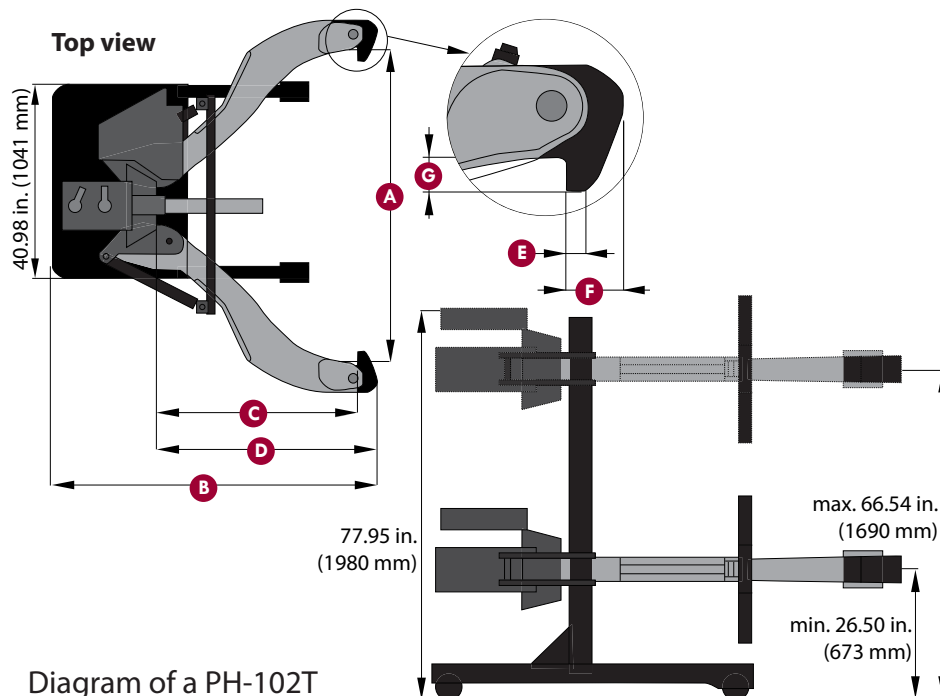

Diagram of a PH-102T

POSI LOCK® 100-TON & 200-TON Hydraulic Puller Systems Overview

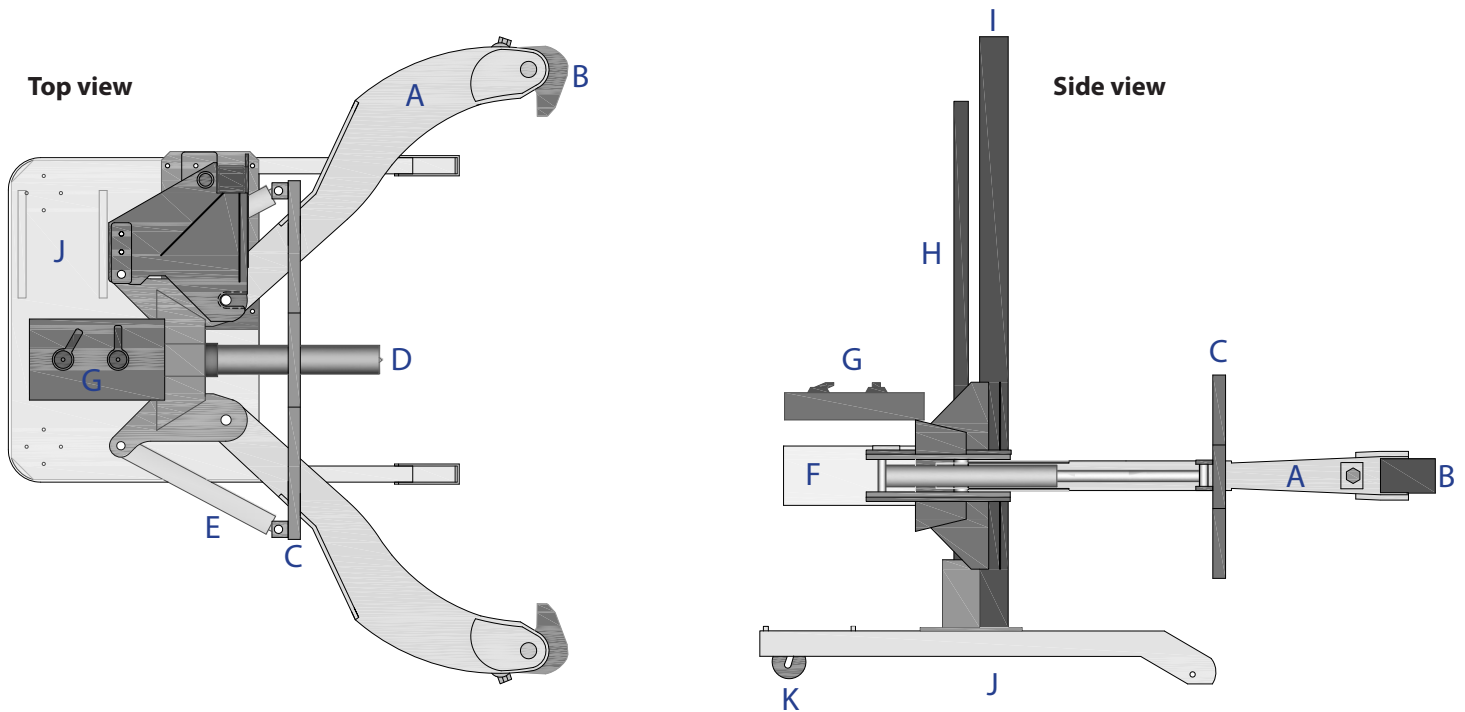

Diagram of a PH-102T

- A.** Jaw
- B.** Jaw Tip
- C.** Cage
- D.** Pushing Adaptor
- E.** Cage Cylinder
- F.** Pushing Cylinder
- G.** Control Valves
- H.** Hoist Cylinder
- I.** Mast
- J.** Base
- K.** Casters

POSI LOCK® 100-TON & 200-TON Hydraulic Puller Systems

Pushers | Jaw Tips

PUSHERS:

Included with the 100-Ton pullers are THREE pushers and a coupler. String 2 pushers together to increase the reach of the ram. Using a variety of combinations may be necessary to complete the pull of a deeply set gear or bearing.

Included with the 200-Ton puller are FOUR pushers. The diameters are 4 inches. The 200-T does not include a coupler.

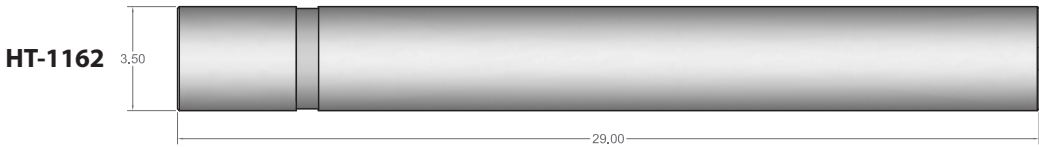
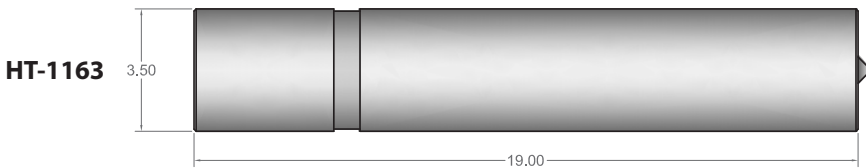
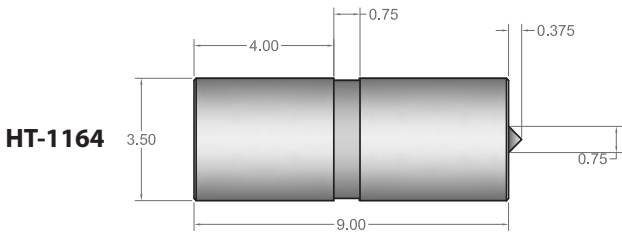

Coupler

*Not included with the 200-Ton.

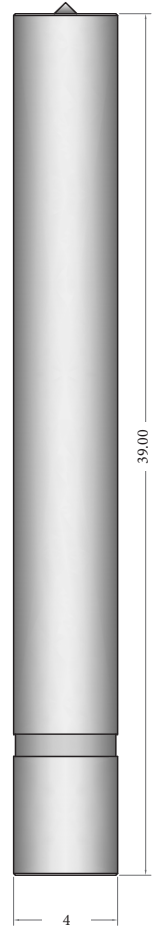
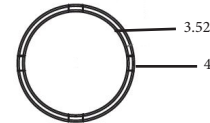
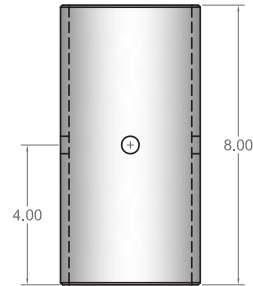

*Included with 200-Ton only.

JAW TIPS:

3 jaw tip sizes are available for 100 and 200 Ton puller models.

- HT-1180: standard with all models.
- HT-1180A: optional, for operations with limited space constraints.
- HT-1180S: optional, for operations with limited space constraints.

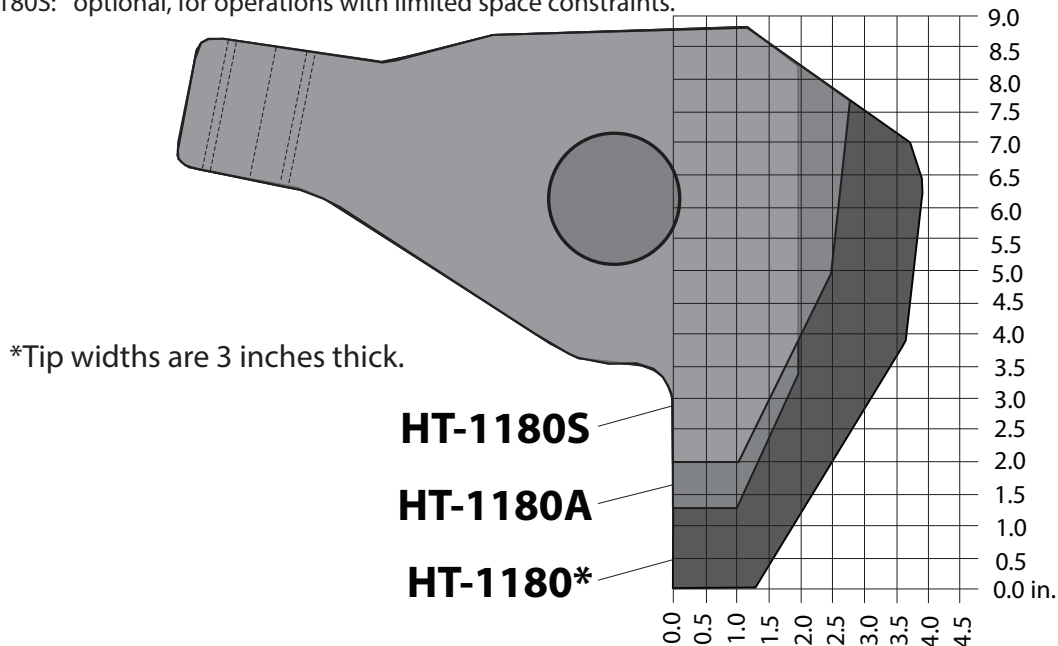

POSI LOCK® 100-TON & 200-TON Hydraulic Puller Systems Assembly | Adjustments

ASSEMBLY:

1. Ensure that shipping crate firmly rests on level ground in upright position.
2. Open small side panel and confirm that puller is resting firmly in upright position in the crate.
3. Remove remainder of plywood.
4. Inspect puller for any damage that may have been caused by shipping.
5. **Save bolts** that were used to brace the cart. These will be used for securing the included cart wheels to the cart.
6. Inspect hoses for proper ratings. Connect the 10,000 psi hose to the port marked "**10,000 psi only**" on the puller and the pressurized port on the pump. Connect hose with the lower pressure rating to the return port on puller and pump.
7. Fill reservoir of pump with pump manufacturer specified oil. See pump or cylinder manual for details.

ADJUSTMENTS:

RAISING THE PULLER:

1. Place cylinder control valve lever in "Hoist Oil Supply" position.
2. Raise puller by placing remote jog switch in "On" position and opening the puller hoist vertical control valve.
3. Release remote jog switch. Close vertical control valve after reaching desired height.

LOWERING THE PULLER:

1. Place cylinder control valve lever in "Hoist Lower" position.
2. Lower puller by turning puller hoist vertical control valve counterclockwise.
3. Close vertical control valve after reaching desired height.

NOTE:

HOIST TRAVEL SPEED:

The restrictor valve, located at the top of the hoist cylinder, is used to control the rate of puller descent. This valve should be set at the desired rate and locked in place using the nut on the valve shaft.

An appropriate starting point is one full turn from the closed position. This valve is a one-way restrictor only and does not affect the rate at which the puller is raised.

CHANGING THE JAW SPREAD:

If opening/closing the jaws using the standard cage setting does not provide enough spread or does not provide enough closure, use the following adjustments to achieve the maximum and minimum spreads.

1. Support the jaws.
2. Remove 6 cap screws, lock washers and nuts on 1 jaw guide at a time.
3. Slide jaw guide inward/outward on cage 1 bolt hole.
4. Replace 4 cap screws, lock washer, and nuts and tighten appropriately.
5. Reverse this process to return to standard jaw spread.

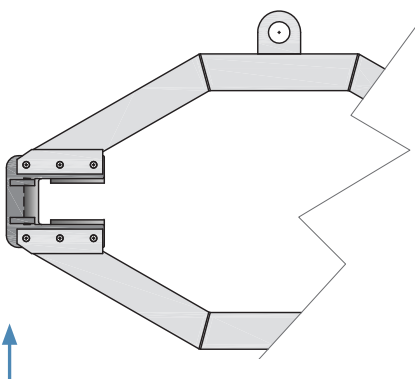

Default jaw guide position when puller is shipped.

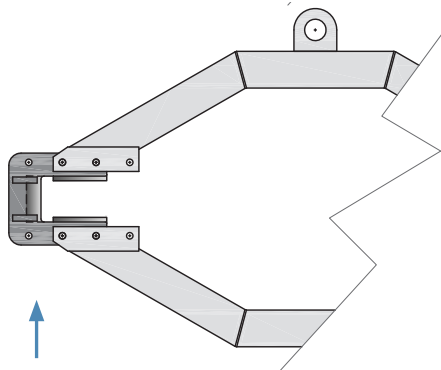

Jaw guide moved 1 bolt hole **OUT** to increase spread.

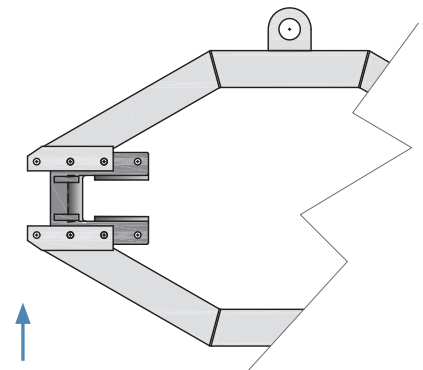

Jaw guide moved 1 bolt hole **IN** to decrease spread.

POSI LOCK® 100-TON & 200-TON Hydraulic Puller Systems

Adjustments (continued) | Removing puller from cart

ADJUSTING JAW TIPS:

1. Adjust jaw tips by turning 1 ¼" cap screw.

NOTE: Always use maximum pulling surface of jaw. To angle tip inward, turn cap screw clockwise. To angle tip outward, turn cap screw counterclockwise. Before pulling, always make certain machined caps are properly fitted to curved surface.

Correct Alignment

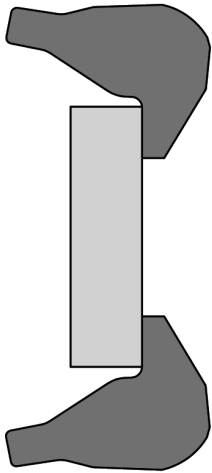

Incorrect

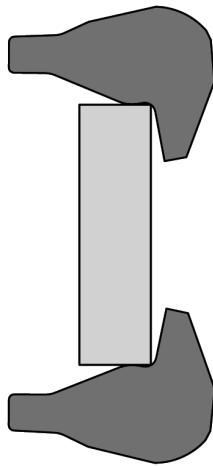

Incorrect

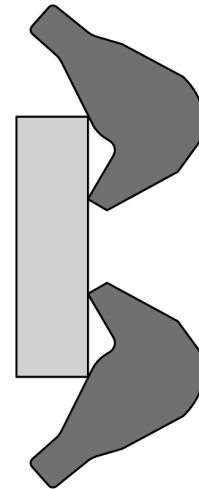

ADJUSTING SLIDE ROLLERS:

1. Lower slide and puller assembly until it rests solidly on base.
2. Loosen 5/8" hex bolt.
3. Move roller using eye bolts on each side of roller.
4. Adjust roller until equal spacing is obtained between mast and slide tube on both roller side and opposite side.
5. Tighten locking nut on eye bolt.
6. Tighten 5/8" hex bolt.

100-TON:

REMOVING PULLER FROM THE CART:

1. Support puller weight using lifting brackets provided.
2. Close puller hoist vertical control valve.
3. Disconnect puller hoist hose coupler at control panel.
4. Remove 2 of the ½" bolts which fasten locking plate to the puller lift bracket.
5. Remove puller from cart by rotating cart while keeping puller stationary.

200-TON:

REMOVING PULLER FROM THE CART:

1. Support puller weight using lifting brackets provided.
2. Close puller hoist vertical control valve.
3. Disconnect puller hoist hose coupler at control panel.
4. On each slide, remove the top and bottom ½" bolts. Do this on both the left and right slide, removing a total of 4 bolts.
5. While keeping the puller supported and balanced, remove from the cart by moving the puller forward.

POSI LOCK® 100-TON & 200-TON Hydraulic Puller Systems Set-up | Pulling an object



OPERATION IMPORTANT: Hydraulic power is one of the safest methods for applying force when used correctly. Be sure to read all instructions, warnings and cautions carefully.

Follow all safety precautions to avoid personal injury or property damage during system operation. Posi Lock cannot be responsible for damage or injury resulting from unsafe use of product, lack of maintenance or incorrect product and/or system operation.

It is important that the operator has a full understanding of all the instructions, warnings, cautions and safety regulations before starting to operate equipment. When in doubt contact Posi Lock at +1-701-797-2600.



MAINTENANCE: Always clean the puller after use and store in a clean, dry place.

SET-UP:

1. Transport the puller by use of the puller cart or forklift.
2. Line the puller up to the workpiece.
3. Open the jaws.



OPENING THE JAWS:

- I. Place cylinder control valve lever in "Oil Supply" position.
- II. Place cage control lever in "Jaw Open" position and activate pump by pushing remote switch to the "On" position to open jaws to the desired spread.

4. Position the workpiece to be removed in between the jaws.
5. Continue to adjust the height until the workpiece and extending cylinder are aligned. See RAISING THE PULLER on page 3.
6. Close the jaws.



CLOSING THE JAWS:

- I. Place cylinder control valve lever in "Oil Supply" position.
- II. Place cage control lever in "Jaw Closed" position and activate pump by pushing remote switch to the "On" position to close jaws to the desired spread or for clamping.

7. Adjust the jaw tips appropriately. See ADJUSTING JAW TIPS on page 4.

PULLING AN OBJECT:

1. Extend the cylinder ram towards the workpiece until there is contact.



EXTENDING CYLINDER:

- I. Place cylinder control valve in "Extend" position.
- II. Activate pump with jog switch.

2. Continue to extend the ram. The workpiece will begin to move gradually off the shaft.
3. Retract the cylinder.
4. Completely remove the workpiece.



RETRACTING CYLINDER:

- I. Place cylinder control valve in the "Retract" position.
- II. Activate pump with jog switch.

NOTE: On a single acting cylinder the cylinder ram will retract without activating the pump.

POSI LOCK® 100-TON & 200-TON Hydraulic Puller Systems PH-123T Transformation

1. Starting in a 2-jaw configuration, move the cage cylinder from the 2-jaw position to the 3-jaw position.



2. Remove the jaw on the left from the 2-jaw position.



POSI LOCK® 100-TON & 200-TON Hydraulic Puller Systems PH-123T Transformation (continued)

3. Place the jaw into the lower 3-jaw position.



4. Place jaw from the left 2-jaw position into upper 3-jaw position to complete the transformation.

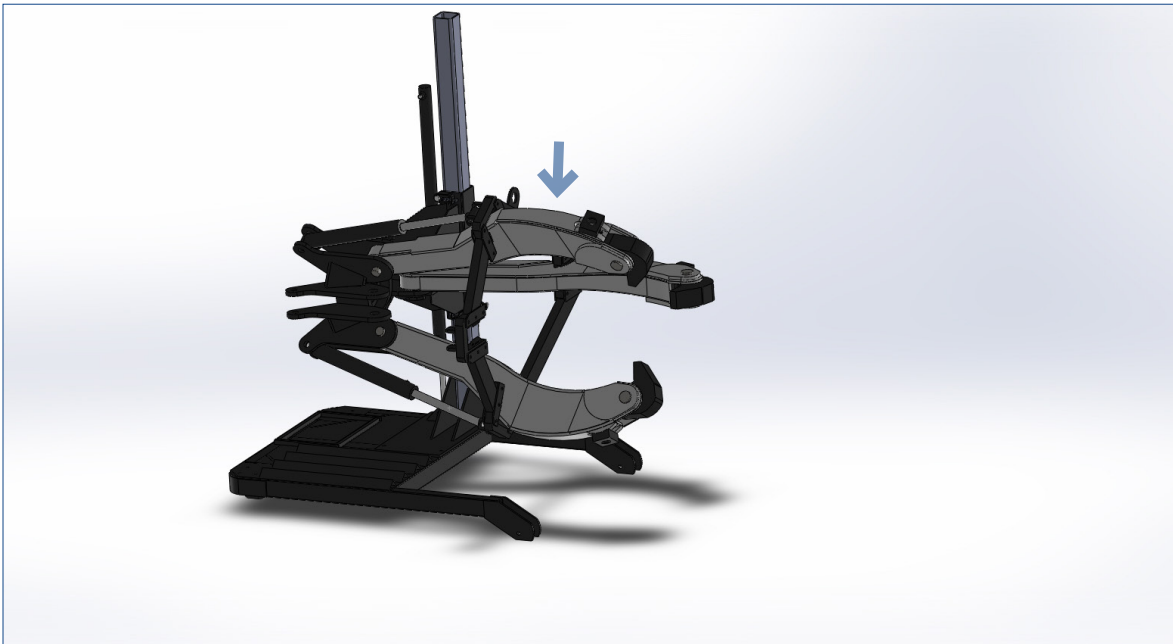

POSI LOCK® 100-TON & 200-TON Hydraulic Puller Systems Spread Range

SPREAD RANGE DIAGRAM:

Use the diagram to determine the limitations of the jaw-opening. Spread ranges apply to all POSI LOCK 100-Ton and 200-Ton hydraulic puller systems. Gears, pulleys, wheels, sleeves, and other press fit parts must fit within these limitations.

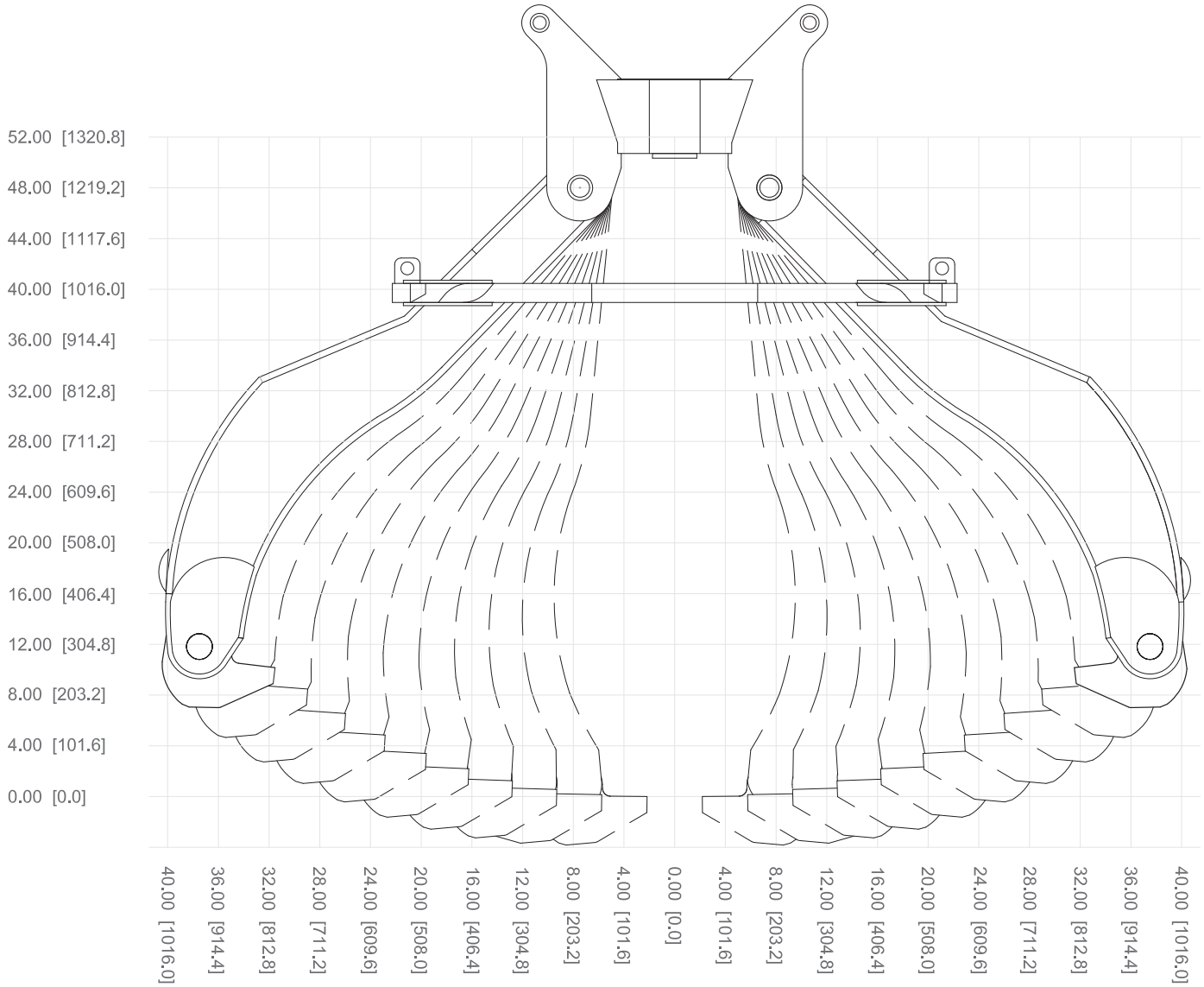



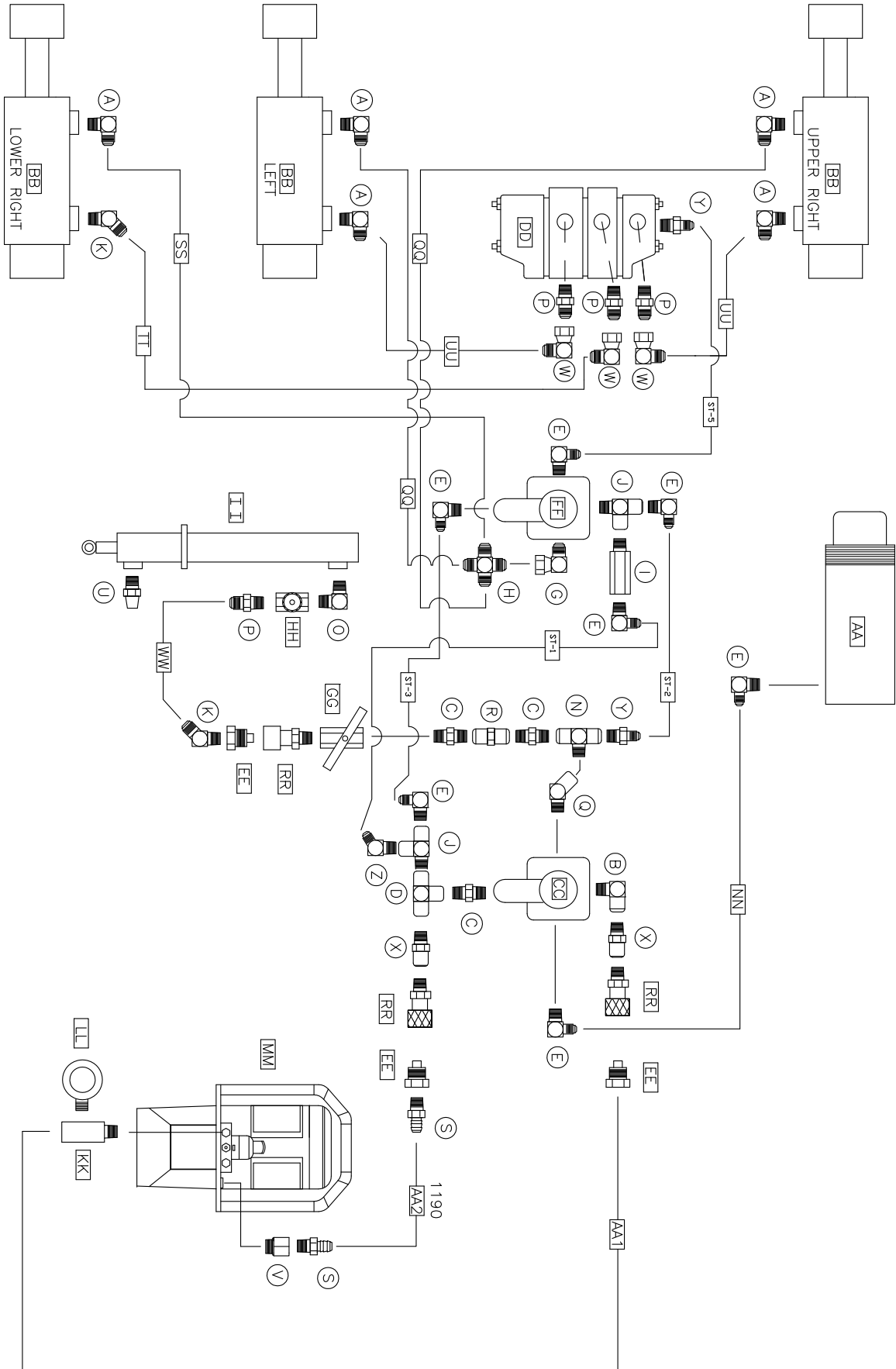



















POSI LOCK® 100-TON & 200-TON Hydraulic Puller Systems Schematics | PH-100T | PH-123T



POSI LOCK® 100-TON & 200-TON Hydraulic Puller Systems

Hydraulic Fittings | PH-100T | PH123T

Hydraulic Fittings for 3 Jaw 100-Ton Pullers				
	SYM	PART #	DESC.	QTY
	A	HT-1123	3/8 Male NPTF x 3/8 Male 37°	5
	B	HT-1124	3/8 Male NPTF x 3/8 Male 37 NPTF	1
	C	HT-1125	3/8 Male NPTF x 3/8 Female NPTF	3
	D	HT-1126	3/8 Female NPTF Tee	1
	E	HT-1134	3/8 Male NPTF x 1/4 Male 37°	7
	G	HT-1128	3/8 Male NPTF x 3/8 Female 37°	1
	H	HT-1129	3/8 Male 37° Cross	1
	I	HT-1113	3/8 Male NPTF x 3/8 Female NPTF 2000 PSI Relief	1
	J	HT-1130	3/8 Male NPTF x 3/8 Female NPTF x 3/8 Female NPTF	2
	K	HT-1131	3/8 Male NPTF x 3/8 37°	2
	N	HT-1001	3/8 Male NPTF x 3/8 Female NPTF x 3/8 Female NPTF	1
	O	HT-1002	3/8 Male NPTF x 3/8 Male NPTF	1
	P	HT-1003	3/8 Male NPTF x 3/8 37°	4
	Q	HT-1004	3/8 Male NPTF x 3/8 Female NPTF	1
	R	HT-1011	3/8 Female NPTF x 3/8 Female NPTF	1
	S	HT-1191	3/8 Male NPTF x 3/8 Male Barbed	2
	U	HT-1154	3/8 Male NPFT Vent	1
	V	HT-1006	3/8 Female NPTF x 3/4 BOSS	1
	W	HT-1013	3/8 Male 37° x 3/8 Female 37°	3
	X	HT-1014	3/8 Male NPTF x 3/8 Female NPTF	2
	Y	HT-1134A	3/8 Male NPTF x 1/4 Male 37°	2
	Z	HT-1134B	3/8 Male NPTF x 1/4 Male 37°	1

POSI LOCK® 100-TON & 200-TON Hydraulic Puller Systems

Hydraulic Hoses and Components | PH-100T | PH123T

Hydraulic Hoses and Components for 3 Jaw 100-Ton Pullers			
SYM	PART #	DESC.	QTY
AA	PH10010	100-Ton Cylinder	1
BB	HT-1103	3-Ton Cylinder	3
CC	HT-VC4	4-Way Valve	1
DD	HT-1114	3 Section Flow Divider	1
EE	FHCH-38M	Male Coupler	3
FF	HT-VC20	4-Way Closed Center Valve	1
GG	HT-V82	Needle Valve	1
HH	HT-1121	1-Way Valve	1
II	HT-1117	Hoist Cylinder	1
KK	HT-GA3	Gauge Adaptor	1
LL	PGB254TLM	10,000 PSI Gauge	1
MM	PH-2022	Pump	1
NN	HT-1135	16" 10,000 PSI Hose	1
QQ	HT-1139	33" Hose	2*
RR	FHCH-38F	Female Coupler	3
SS	HT-1140	44" Hose	1**
TT	HT-1141	21" Hose	1
UU	HT-1142A	15" Hose	2
WW	HT-1005	30" Hose	1
AA1	PH-927	10' 10,000 PSI Hose	1
AA2	HT-1190	10' Return Hose	1
ST-1	HT-ST1	Steel Line	1
ST-2	HT-ST2	Steel Line	1
ST-3	HT-ST3	Steel Line	1
ST-4	HT-ST4	Steel Line	1

SPECIAL NOTES:

* 1- 33" hose is included for the 2/3 jaw combination puller.





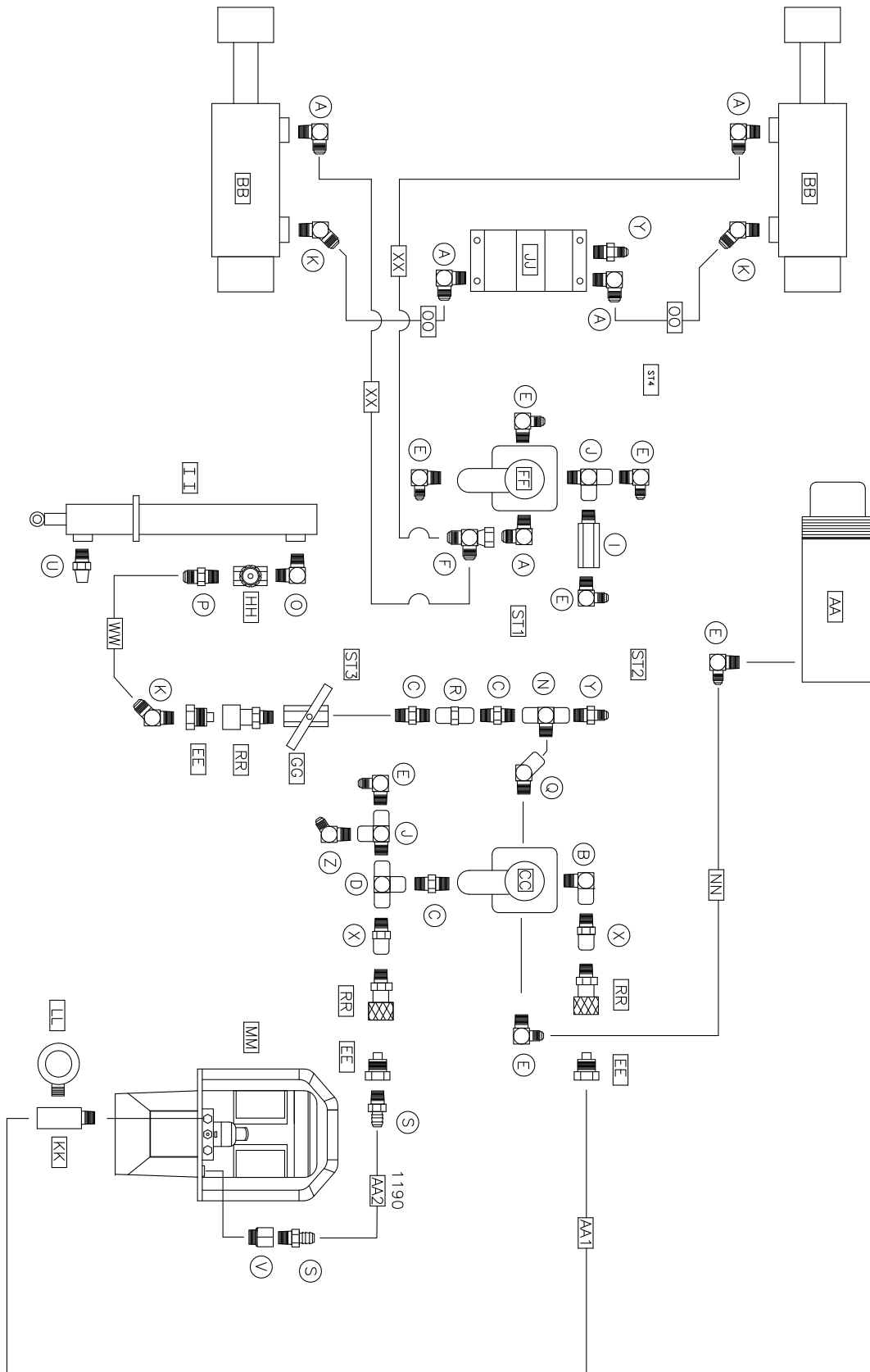















** 2- 44" hoses are included with the 2/3 jaw combination puller.

POSI LOCK® 100-TON & 200-TON Hydraulic Puller Systems Schematics | PH-102T



POSI LOCK® 100-TON & 200-TON Hydraulic Puller Systems

Hydraulic Fittings, Hoses and Components | PH-102T

Hydraulic Fittings for 2 Jaw Pullers				
	SYM	PART #	DESC.	QTY
	A	HT-1123	3/8 Male NPTF x 3/8 Male 37°	5
	B	HT-1124	3/8 Male NPTF x 3/8 Male 37 NPTF	1
	C	HT-1125	3/8 Male NPTF x 3/8 Female NPTF	3
	D	HT-1126	3/8 Female NPTF Tee	1
	E	HT-1134	3/8 Male NPTF x 1/4 Male 37°	7
	F	HT-1127	3/8 Male 37° x 3/8 Female 37° x 3/8 Male 37°	1
	I	HT-1113	3/8 Male NPTF x 3/8 Female NPTF 2000 PSI Relief	1
	J	HT-1130	3/8 Male NPTF x 3/8 Female NPTF x 3/8 Female NPTF	2
	K	HT-1131	3/8 Male NPTF x 3/8 37°	3
	N	HT-1001	3/8 Male NPTF x 3/8 Female NPTF x 3/8 Female NPTF	1
	O	HT-1002	3/8 Male NPTF x 3/8 Male NPTF	1
	P	HT-1003	3/8 Male NPTF x 3/8 37°	1
	Q	HT-1004	3/8 Male NPTF x 3/8 Female NPTF	1
	R	HT-1011	3/8 Female NPTF x 3/8 Female NPTF	1
	S	HT-1191	3/8 Male NPTF x 3/8 Male Barbed	2
	U	HT-1154	3/8 Male NPFT Vent	1
	V	HT-1006	3/8 Female NPTF x 3/4 BOSS	1
	X	HT-1014	3/8 Male NPTF x 3/8 Female NPTF	2
	Y	HT-1134A	3/8 Male NPTF x 1/4 Male 37°	2
	Z	HT-1134B	3/8 Male NPTF x 1/4 Male 37°	1

POSI LOCK® 100-TON & 200-TON Hydraulic Puller Systems







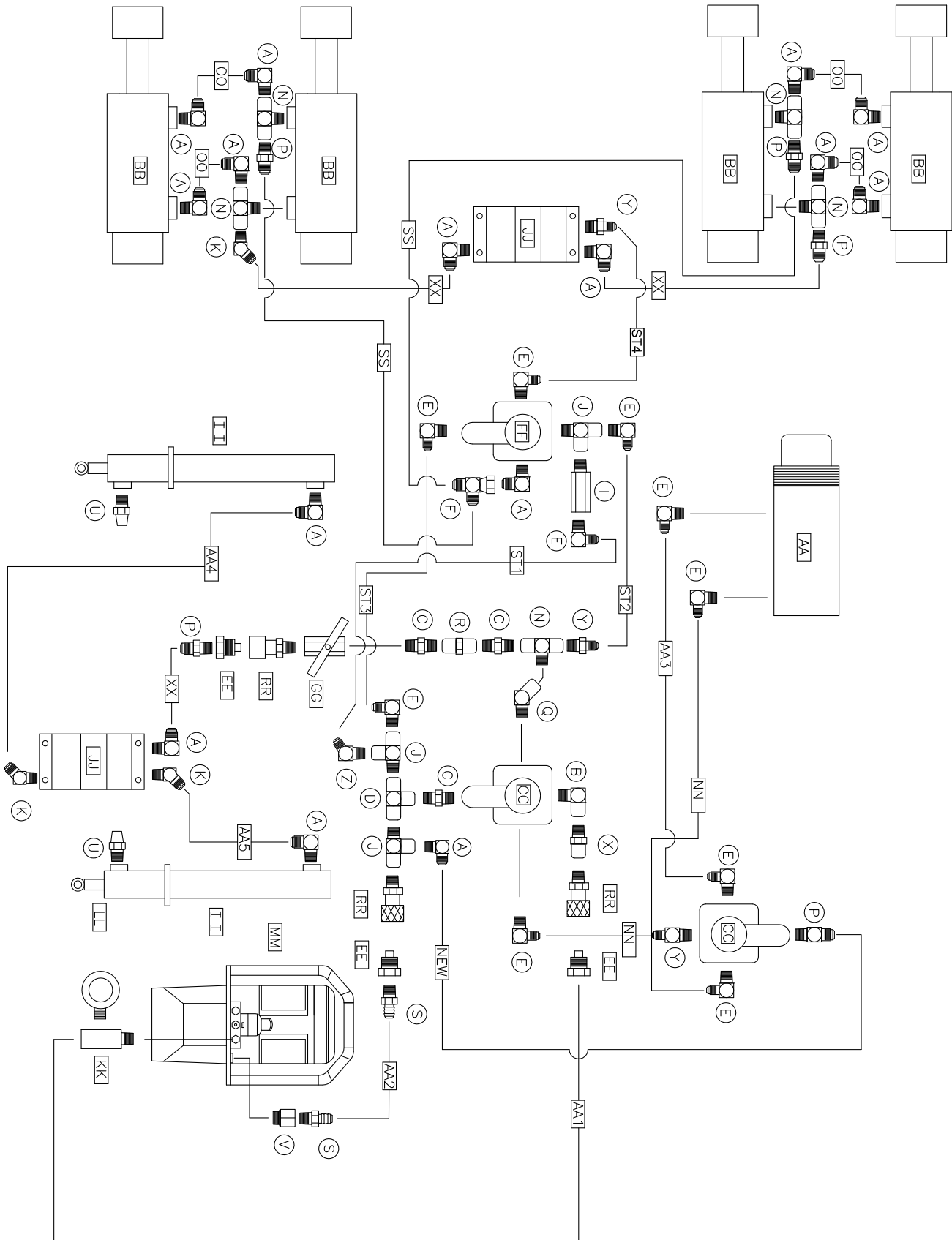











Hydraulic Fittings, Hoses and Components | 102T

Hydraulic Hoses and Components for 2 Jaw 100-Ton Pullers			
SYM	PART #	DESC.	QTY
AA	PH10010	100-Ton Cylinder	1
BB	HT-1103	3-Ton Cylinder	2
CC	HT-VC4	4-Way Valve	1
EE	FHCH-38M	Male Coupler	3
FF	HT-VC20	4-Way Closed Center Valve	1
GG	HT-V82	Needle Valve	1
HH	HT-1121	1-Way Valve	1
II	HT-1117	Hoist Cylinder	1
JJ	HT-1187	2 Section Flow Divider	1
KK	HT-GA3	Gauge Adaptor	1
LL	PGB254TLM	10,000 PSI Gauge	1
MM	PH-2022	Pump	1
NN	HT-1135	16" 10,000 PSI Hose	1
OO	HT-1136	12 1/4" Hose	2
RR	FHCH-38F	Female Coupler	3
WW	HT-1005	30" Hose	1
XX	HT-1139	33" Hose	2
AA1	PH-927	10' 10,000 PSI Hose	1
AA2	HT-1190	10' Return Hose	1
ST-1	HT-ST1	Steel Line	1
ST-2	HT-ST2	Steel Line	1
ST-3	HT-ST3	Steel Line	1
ST-4	HT-ST4	Steel Line	1

POSI LOCK® 100-TON & 200-TON Hydraulic Puller Systems Schematics | PH-200T



POSI LOCK® 100-TON & 200-TON Hydraulic Puller Systems Hydraulic Fittings | PH-200T

Hydraulic Fittings for 200-Ton Puller				
	SYM	PART #	DESC.	QTY
	A	HT-1123	3/8 Male NPTF x 3/8 Male 37°	15
	B	HT-1124	3/8 Male NPTF x 3/8 Male 37 NPTF	1
	C	HT-1125	3/8 Male NPTF x 3/8 Female NPTF	3
	D	HT-1126	3/8 Female NPTF Tee	1
	E	HT-1134	3/8 Male NPTF x 1/4 Male 37°	10
	F	HT-1127	3/8 Male 37° x 3/8 Female 37° x 3/8 Male 37°	1
	I	HT-1113	3/8 Male NPTF x 3/8 Female NPTF 2000 PSI Relief	1
	J	HT-1130	3/8 Male NPTF x 3/8 Female NPTF x 3/8 Female NPTF	3
	K	HT-1131	3/8 Male NPTF x 3/8 37°	3
	N	HT-1001	3/8 Male NPTF x 3/8 Female NPTF x 3/8 Female NPTF	5
	P	HT-1003	3/8 Male NPTF x 3/8 37°	5
	Q	HT-1004	3/8 Male NPTF x 3/8 Female NPTF	1
	R	HT-1011	3/8 Female NPTF x 3/8 Female NPTF	1
	S	HT-1191	3/8 Male NPTF x 3/8 Male Barbed	2
	U	HT-1154	3/8 Male NPFT Vent	2
	V	HT-1006	3/8 Female NPTF x 3/4 BOSS	1
	X	HT-1014	3/8 Male NPTF x 3/8 Female NPTF	1
	Y	HT-1134A	3/8 Male NPTF x 1/4 Male 37°	3
	Z	HT-1134B	3/8 Male NPTF x 1/4 Male 37°	1

POSI LOCK® 100-TON & 200-TON Hydraulic Puller Systems

Hydraulic Hoses and Components | PH-200T

Hydraulic Hoses and Components for 200-Ton Puller			
SYM	PART #	DESC.	QTY
AA	PH20013	200-Ton Cylinder D/A	1
BB	HT-1103	3-Ton Cylinder	4
CC	HT-VC4	4-Way Valve	2
EE	FHCH-38M	Male Coupler	3
FF	HT-VC20	4-Way Closed Center Valve	1
GG	HT-V82	Needle Valve	1
II	HT-1117	Hoist Cylinder	2
JJ	HT-1187	2 Section Flow Divider	2
KK	HT-GA3	Gauge Adaptor	1
LL	PGB254TLM	10,000 PSI Gauge	1
MM	PH-2022	Pump	1
NN	HT-1135	16" 10,000 PSI Hose	2
OO	HT-1136	12 1/4" Hose	4
RR	FHCH-38F	Female Coupler	3
SS	HT-1140	46" Hose	2
XX	HT-1139	33" Hose	3
AA1	PH-927	10' 10,000 PSI Hose	1
AA2	HT-1190	10' Return Hose	1
AA3	HT-1135-7	23" 10,000 PSI Hose	1
AA4	HT-34	34" Hose with 3" Elbow	1
AA5	HT-78	78" Hose	1
ST-1	HT-ST1	Steel Line	1
ST-2	HT-ST2	Steel Line	1
ST-3	HT-ST3	Steel Line	1
ST-4	HT-ST4	Steel Line	11

POSI LOCK® 100-TON & 200-TON Hydraulic Puller Systems Parts List

PART #	DESC.	QUANTITY		
		100T/123T	102T	200T
HT-1001	Fitting N 6 fp-fp-mp	1	1	5
HT-1002	Fitting O 6MP-6MP90	1	1	-
HT-1003	Fitting P 8MJ-6MP	4	1	5
HT-1004	Fitting Q 6MP-6FP45	1	1	-
HT-1005	Hose WW-115 30"	1	1	-
HT-1006	Fitting 3/4" male 3/8 FP	1	-	1
HT-1011	Fitting R 6FP-6FP	1	1	1
HT-1013	Fitting 1/2" MJ X1/2 FJ80	3	-	-
HT-1014	Fitting 13/8" MP X 3/8" FP	2	2	1
HT-1015	5/8" hex lock nut	4	4	4
HT-1016	1/2" hex nut	29	23	32
HT-1017	1/2" lock washer	25	19	30
HT-1018	3/8" hex nut	12	8	-
HT-1019	3/8" lock washer	12	12	-
HT-1020	1/4" lock washer	4	4	6
HT-1021	1/4" flat washer	4	4	-
HT-1022	3/8" hex Lock nut	4	4	8
HT-1023	3/8" flat washer	4	4	-
HT-1024	5/16"X1 hex head cap screw	-	4	12
HT-1025	5/16" hex nut	-	4	8
HT-1026	5/16" lock washer	-	4	12
HT-1027	5/16" flat washer	-	4	-
HT-1028	5/8"X6" hex cap screw grade 8	2	2	4
HT-1051	1/4"X3/4" hex cap screw	4	4	6
HT-1052	1/2"X 1-1/2" hex cap screw	3	3	18
HT-1053	1/2"X1/4" sock head cap screw	2	2	-
HT-1054	1/2X1/2 Socket set screw	1	1	1
HT-1057	Decal (hoist oil)	1	1	1
HT-1058	Self drilling screws	8	6	8
HT-1103	3 -Ton cylinder # 2016	3	2	4
HT-1104	Jaw	3	2	4
HT-1105	Jaw head for 3 jaw	1	-	-

POSI LOCK® 100-TON & 200-TON Hydraulic Puller Systems Parts List (continued)

PART #	DESC.	QUANTITY		
		100T/123T	102T	200T
HT-1106A	Pin (1" X 4-1/8")	4	3	6
HT-1106A-23	Pin (1" X 4-1/8") not plated	-	-	1
HT-1106B	Pin (1" X 6-1/2")	1	1	-
HT-1106C	Pin (1" X 5-1/4")	2	1	-
HT-1107	1" external snap ring	14	10	16
HT-1111	Cart	1	1	-
HT-1111A	Mast	1	1	-
HT-1111B	Slide (puller holder)	1	1	-
HT-1113	Relief valve #RV-38-K-2000	1	-	1
HT-1114	Flow divider 3 jaw and combo	1	1	-
HT-1117	Mast Cylinder #1540	1	1	2
HT-1117B	Roller adjuster	4	4	8
HT-1118B	Bushing	2	2	4
HT-1119B	Roller	2	2	4
HT-1121	Flow control valve	1	1	-
HT-1123	Fitting A 6mp-8mj90	5	5	15
HT-1124	Fitting B 6mp-fp90	1	1	1
HT-1125	Fitting C 6mp-6mp	3	3	3
HT-1126	Fitting D 6fpt	1	1	1
HT-1127	Fitting F 8fjx-8mj-8mj	0	1	1
HT-1128	Fitting G 6mp-8fjx90	1	-	-
HT-1129	Fitting H 8mj-cross	1	-	-
HT-1130	Fitting J 6fp-6mp-6fp	2	2	3
HT-1131	Fitting K 6mp-8mj45	2	3	3
HT-1134	Fitting E 6mp-6mj90	7	7	10
HT-1134A	Straight fitting 6mp-6mj	2	2	2
HT-1134B	45 degree fitting 6mp-6mj45	1	1	2
HT-1135	Hose NN-101 15" high jack	1	1	-
HT-1135-7	Hose NN-101-23" high jack	-	-	2
HT-1135-15	Hose AA6-101-32" high jack	-	-	1
HT-1136	OO hose-103 12.25"	-	1	4
HT-1139	XX-112 33" hose	2	2	3

POSI LOCK® 100-TON & 200-TON Hydraulic Puller Systems Parts List (continued)

PART #	DESC.	QUANTITY		
		100T/123T	102T	200T
HT-1142A	Hose YY-116 15"	2	-	-
HT-1144	Decal 100-Ton	1	-	-
HT-1145	Decal, 100-Ton cyl/sup oil	1	1	1
HT-1146	Decal, lift area	2	2	4
HT-1147	Decal, 10,000 PSI	1	1	1
HT-1148	Decal, jaw area	2	2	4
HT-1149	Decal, return oil	1	1	1
HT-1150	Decal, 100-Ton 2 jaw	-	1	-
HT-1153	Control cover	1	1	1
HT-1154	3/8" male vent #4450K3	1	1	2
HT-1155	Caster	2	2	-
HT-1156	Wheel	2	2	-
HT-1158	Cage rail w/o eyelet 3-2/3jaw	2	-	-
HT-1159	Jaw guide	3	2	-
HT-1160A	Pin (1-1/2"X 5 1/4"	2	1	-
HT-1160-B	Pin (1-1/2" X 6")	1	1	-
HT-1161	1-1/2" external snap ring	6	4	4
HT-1162	Pusher 3-1/2" X 29"	1	1	-
HT-1163	Pusher 3-1/2" X 19"	1	1	-
HT-1164	Pusher 3-1/2"X 9"	1	1	-
HT-1165	1/2" X 4" hex cap screw	4	4	-
HT-1166	3/8"X 3" hex cap screw	8	8	-
HT-1167	Plate, Puller Lock	1	1	-
HT-1168	Cage rail for Combo 2/3 only	2	-	-
HT-1170	Control valve mounting bracket	1	1	1
HT-1171	1/2" X 2-1/2" hex cap screw	18	12	-
HT-1172	Cage rail w/eyelet 3-2/3 jaw	1	-	-
HT-1175	5/8" X 4" hex cap screw	2	2	-
HT-1176	Decal, hoist valve/oil	1	1	1
HT-1178	Decal, cage control	1	1	1
HT-1180	Jaw end	3	2	4
HT-1181	Pin (2" X 6")	3	2	-
HT-1182	2" external snap ring	6	4	4

POSI LOCK® 100-TON & 200-TON Hydraulic Puller Systems Parts List (continued)

PART #	DESC.	QUANTITY		
		100T/123T	102T	200T
HT-1187	Flow divider for 2 jaw	-	1	2
HT-1190	10' return hose	1	1	1
HT-1191	Barbed male hose end	-	-	2
HT-1199	Adapter for pusher	1	1	-
HT-1205	Jaw head for 2 jaw	-	1	-
HT-1206	Cage rail w/ eyelet (2 jaw)	-	1	-
HT-1207	Cage rail w/o eyelet (2 jaw)	-	1	-
HT-1208	Coupler for pusher	1	1	-
HT-20013	200 -Ton cylinder D/A	-	-	1
HT-2005A	Hose AA4 - 34" with 3" elbow	-	-	1
HT-2005B	Hose AA5 - 78"	-	-	1
HT-2159	200-Ton jaw guide	-	-	2
HT-2160A	Pin 1 1/2 x 13 13/16	-	-	2
HT-2162	200-Ton pusher 29"	-	-	1
HT-2163	200-Ton pusher 19"	-	-	1
HT-2164	200-Ton pusher 9"	-	-	1
HT-2181	Pin 2 x 12 3/16	-	-	2
HT-2199	Adaptor for pushers	-	-	1
HT-2204	3-Ton cylinder spacer	-	-	2
HT-2204-1	3-Ton cylinder spacer	-	-	4
HT-2206	200-Ton upper cage	-	-	1
HT-2207	200-Ton lower cage	-	-	1
HT-2210	Jaw guide spacer	-	-	8
HT-2405	Jaw head for 200-Ton puller	-	-	1
HT-9306K34	Bumper stops	-	-	2
HT-2150	Decal, 200-Ton 4 jaw	-	-	1
HT-2171	1/2" x 3 1/4' hex head cap SCR	-	-	12
UW16	1" Dia. hardened washer	-	-	2
HT-1029	1" x 1 1/4" hex head cap SCR	-	-	2
HT-1030	1" lock washer	-	-	2
HT-2170DA	Control valve nounting bracket	-	-	1
HT-2106B	Pin 1 x 12 1/2"	-	-	2

POSI LOCK® 100-TON & 200-TON Hydraulic Puller Systems Parts List (continued)

PART #	DESC.	QUANTITY		
		100T/123T	102T	200T
HT-2111AR	200-Ton Mast	-	-	1
HT-2112	200-Ton Puller Slide	-	-	2
HT-ST1	Steel Tube	1	1	1
HT-ST2	Steel Tube	1	1	1
HT-ST3	Steel Tube	1	1	1
HT-ST4	Steel Tube	-	1	1
HT-ST5	Steel Tube	1	1	-
HT-VC4	4-Way Valve	1	1	2
HT-CH604	Male Coupler	-	-	3
HT-VC20	4-Way Closed Center Valve	1	1	1
HT-V82	Needle Valve	1	1	1
HT-CR400	Female Coupler	-	-	3
PH-10010	100-Ton Cylinder	1	1	-
PH-2022	Electric Pump	1	1	
PGB254TLM	Gauge	1	1	1
HT-GA3	Gauge Adapter	1	1	1
PH-411	Dust Cap	3	3	-
PH-927	Hose 10'	1	-	1
FHCH-38M	Male Coupler	3	3	-
FHCH-38F	Female Coupler	3	3	-
	200-Ton Hydraulic Pump	-	-	1

POSI LOCK® 100-TON & 200-TON Hydraulic Puller Systems WARRANTY

All POSI LOCK forged parts carry a lifetime warranty with the exception of transmission jaws. All other POSI LOCK parts and components are guaranteed for one year against defects in materials and workmanship to meet the exacting standards and requirements of professional maintenance. Every product manufactured by POSI LOCK and found to be defective (by the factory) in either material or workmanship, will be repaired or replaced. This warranty applies to the original purchaser (end user) only and is nontransferable.

This warranty does not cover any product or part that has been abused, worn out, heated, ground or otherwise altered, used for a purpose other than that for which it was intended or used in a manner inconsistent with any instructions regarding its use. Use of an impact wrench voids the warranty.

Damaged components, including bent rams, dented or crushed cylinder walls are the result of misuse, misapplication or a combination of both and will not be considered under warranty. Normal wear such as worn out seals, couplers, O-rings and springs does not constitute a defect and will not be considered for warranty credit. The foregoing constitutes the only warranty made by the company.

In the unlikely event that product fails due to material or workmanship defect, you are instructed to contact the POSI LOCK warranty division at +1- 701- 797-2600 or info@posilock.com. Except where such limitations and exclusions are specifically prohibited by law, the consumer's sole and exclusive remedy shall be the repair or replacement of the defective product.

POSI LOCK shall not be liable for any consequential or incidental damage or loss whatsoever. Any and all expressed and implied warranties, including without limitation, any warranties of merchantability and fitness for a particular purpose, are limited to the original purchaser. Some states do not allow the exclusion or limitation of incidental or consequential damages, so the above may not apply to you. This warranty gives you specific legal rights. You may also have other rights which vary from state to state.

Hydraulic components not manufactured by POSI LOCK. Please refer to the original manufacturer's warranty statement.

Notice: POSI LOCK reserves the right to make changes in design or construction of tools and equipment without obligation to incorporate such changes in tools and equipment previously sold.

Posi Lock Puller, Inc.

805 Sunflower Avenue | PO Box 246 | Cooperstown, North Dakota | USA | 58425

Phone: +1-701-797-2600 | Fax: +1-701-797-2706

info@posilock.com | www.posilock.com

Rev. 2015