

104 PARTS BREAKDOWN

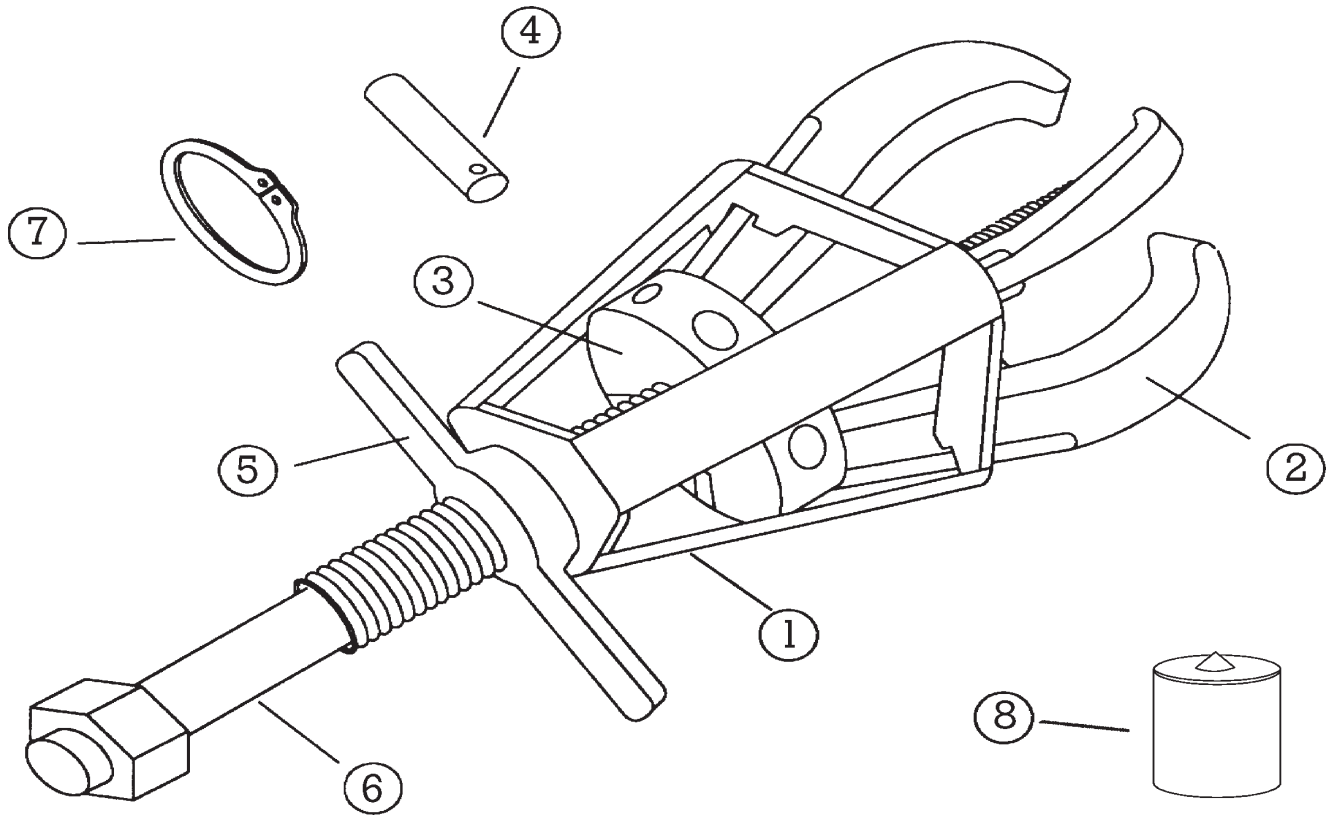

All Posi Lock Pullers are parts replaceable.
 See part numbers below.

Description	Part #
1. Cage® - 3 Jaw	10453
2. Jaw	10454
3. Jaw Head Assembly - 3 Jaw	10455
4. Pin	10456
5. T-Handle	10457
6. Center Bolt (Dia. 9/16")	10458
7. Snap Ring	10459
8. Tip Protector	P4
*Optional accessories are also available	