

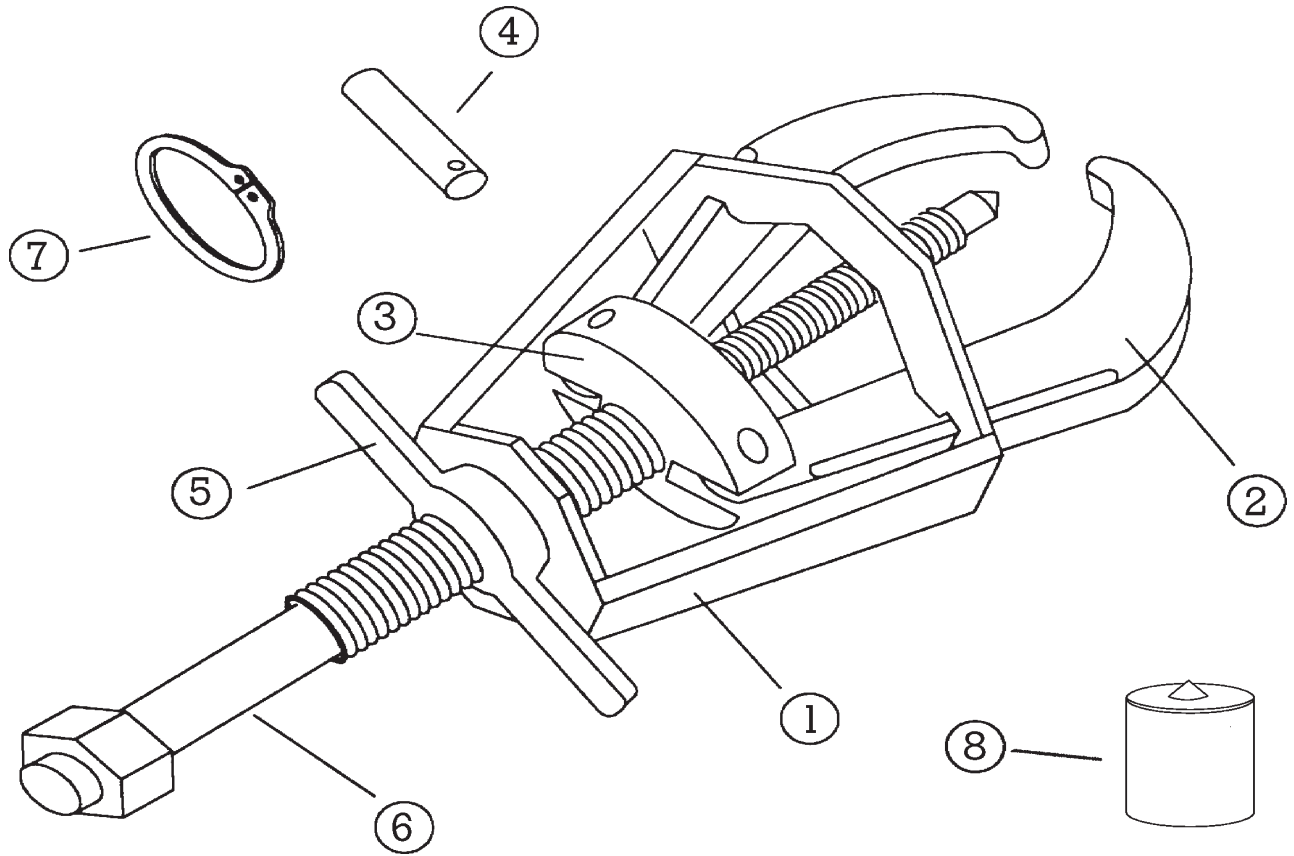

216L PARTS BREAKDOWN



All Posi Lock Pullers are parts replaceable.
See part numbers below.

Description	Part #
1. Cage® - 2 Jaw	21653
2. Jaw	11654L
3. Jaw Head Assembly - 2 Jaw	21655
4. Pin	11356
5. T-Handle	11657
6. Center Bolt (Dia. 1 1/4")	11658
7. Snap Ring	11659
8. Tip Protector	P13/16

*Optional accessories are also available